

Silen Space 2

Collaboration space for allies

This stylish pod filters out the world, its noise and distractions. Comfortable for two (but fits four for shorter meetings), shared purpose turns into real focus here. Meet, create, and collaborate.



 1–4 people





 **Ultimate two-way privacy**
Market-leading in performance. Blocks 43 dB outside noise, 30 dB (Class A) inside speech. Office-tested, ISO-approved in the laboratory.

 **Comfortable**
Ergonomic, quiet, echo-free, and speech-optimized. Automated LEDs and ventilation. Over twice the standard airflow rate.



 **Movable**
Hidden wheels allow effortless relocation in the office. Prefabricated design offers easy disassembly and reassembly when moving.

 **Spacious**
Ample space to sit, stretch, stand, and move around. Available with furniture of your choice.

 **Endless customization**
Swap side skins and cover trims with a snap of a magnet. Choose from a variety of colors, fabrics, and furnishing options.

 **Modularity**
The modular design enables changing the pod size whenever needed. Add modules to create bigger spaces or split larger pods into smaller spaces.

 **Sustainable**
Fully renewable with a 20+ year lifespan. Designed sustainably across materials, production, and impact on surrounding environments.

	Interior colour		Exterior colour
	Standard colours		Standard colours*
	 Light Grey		 White
	 Dark Grey		 Grey
	 Black		 Black
	 Sand / Dark Grey		

Additional colours for extra fee



Textile sides Camira Quest



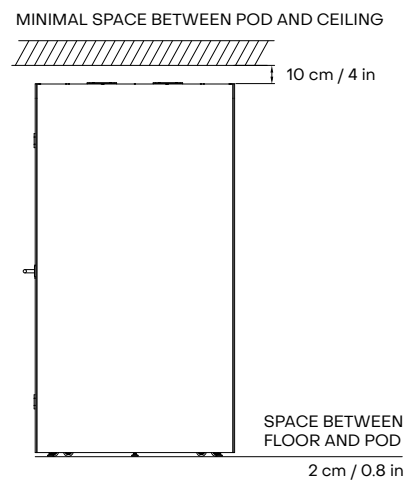
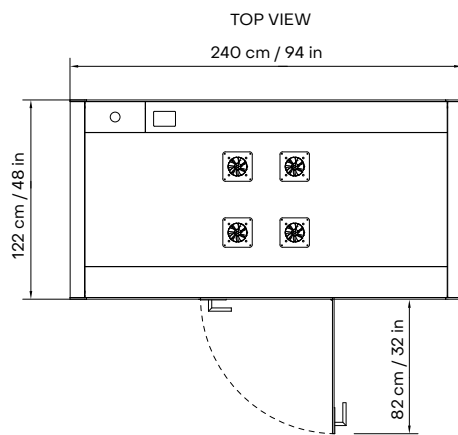
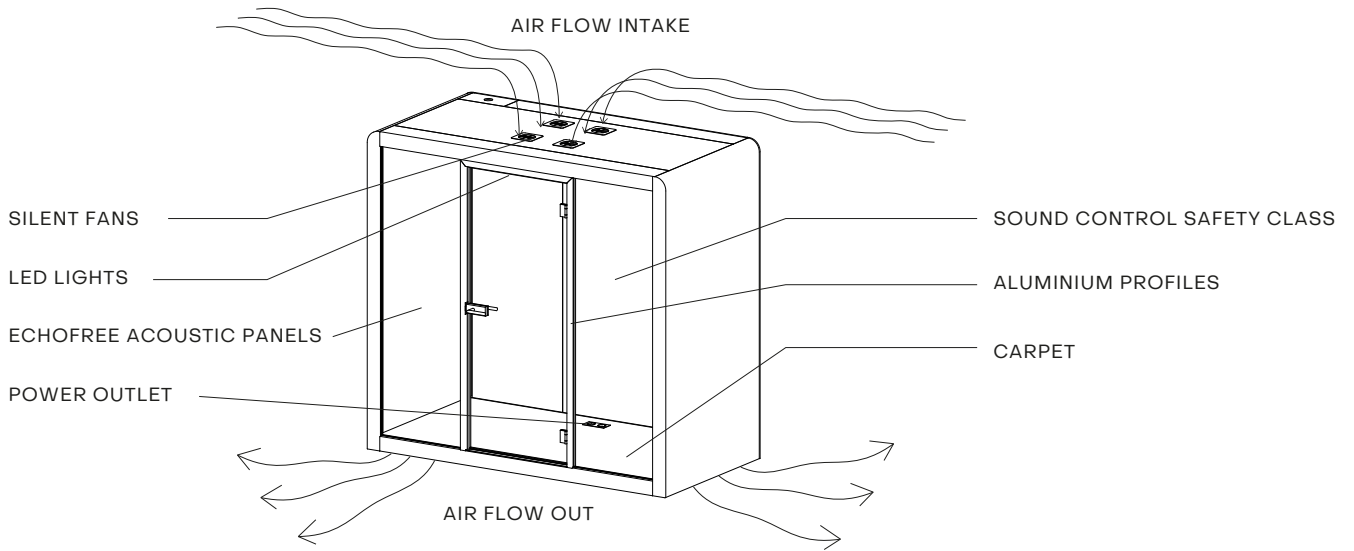
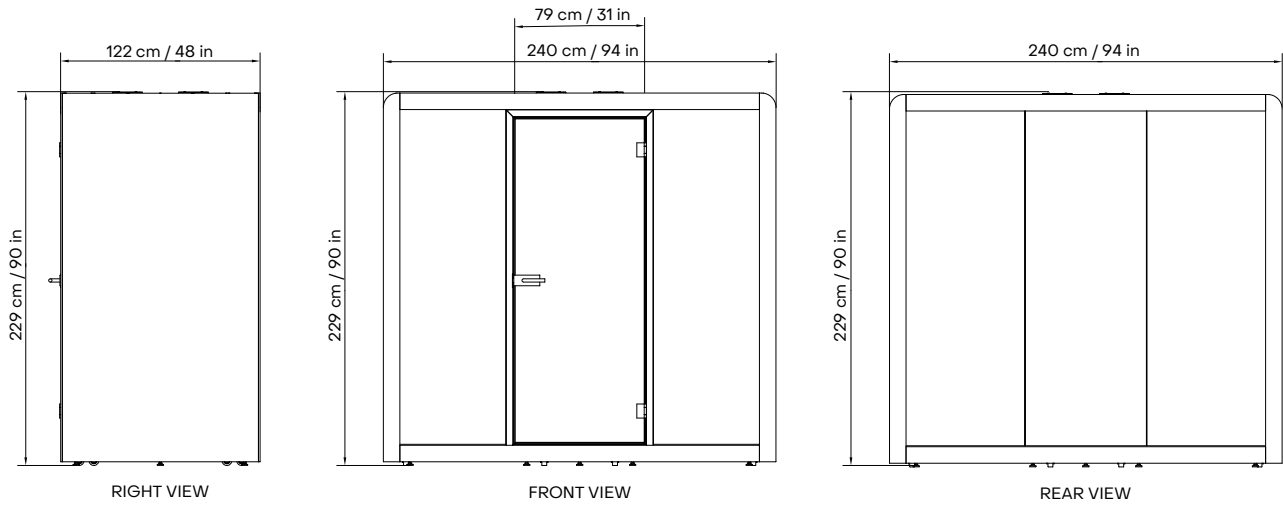

Space 2 technical specification

GENERAL PRODUCT INFO

Exterior size (W×D×H)	240 × 122 × 229 cm / 94 × 48 × 90 in
Interior size (W×D×H)	220 × 116 × 205 cm / 87 × 46 × 81 in
Weight (net)	670 kg / 1477 lb
Weight with crate	800 kg / 1764 lb
Exterior	Exterior panels and cover trims. Medical grade antibacterial laminate
Glass	Sound Control laminated safety glass. Sound insulation STC 40 dB
Walls/structure	EchoFree panel - sandwich element and structure of FSC™ birch plywood, ecological foam and acoustic felt. Sound insulation STC 49 dB. Acoustic absorption class A
Roof	EchoFree panel - sandwich element of birch plywood and acoustic felt. Sound insulation STC 49 dB. Acoustic absorption class A
Floor	Sandwich element of birch plywood, acoustic wool. Acoustic absorption Class B
Carpet	Antistatic and stain resistant low loop pile carpet for public spaces, EN 1307. Flammability B _{fl} -s1
Door handedness	Right- or left-handed door. Door handedness can be chosen
Furniture	Optional. Different sets are available
Air ventilation	Low energy-consumption automatic air circulation system (stand by 3,4W; in operation 6,8W). Air circulation speed is at least 85 l/s
Connections	AC outlet (100–240V) + USB A (optional). Ethernet port (optional).
Power cord	5m long cord with plug type depending on the region. Connection either from the top or bottom of the pod, can be chosen during installation.
Lighting	3000K or 4000K automatic LED lightning (28 W, 900 lm). Low consumption, energy-efficient
Casters	For moving during installation and easy relocation. Hidden. Can be activated any time.
Adjustable legs	For levelling. Levelling from inside the booth

CERTIFICATION

Product safety	UL962 Listed
Electrical safety	CE-mark / UL962 Listed
Fire safety	Class A according to UL 723, ASTM E84, ASTM E162 (walls and ceiling)
Emissions	Indoor Advantage™ Gold certified by SCS Global Services
Speech level reduction	30,4 dB / Class A according to ISO 23351-1, measured in accredited lab
Airborne sound insulation R'w	43 dB according to ISO 16283-1 and ISO 717-1, measured on site by an accredited specialist
Sound transmission class STC	43 dB according to ASTM E90, measured on site by an accredited specialist



Space 2 extra features



Self-closing door hinges



Additional power outlet Pluto under the table



Additional power outlet Desk2 on the table



Additional power outlet Slim on the table (US)



Retractable coat/bag hook



Air flow and lighting dimmer



Occupancy light



Screen bracket on back glass



Seismic kit

EXTRA FEATURE

Self-closing door hinges

Additional power outlet Pluto under the table

Additional power outlet Desk2 on the table

On table top. 2 X 230 V, 1 X USB-A, 1 X USB-C

Additional power outlet Slim on the table (us)

US only. 3 x 120V, 2 x USB-A

Power outlet under sofa

(1 x 230V / USB A/C) Additional information.

LAN/RJ45/HDMI connections

Air flow and lighting dimmer

Occupancy light

Screen bracket on back glass

Screen bracket on side wall

Frosted film on glass

Retractable coat/bag hook

Sprinkler prep

Knockout with a tube inside. The ceiling module for housing a sprinkler. Does not include a sprinkler. Sprinkler needs to be installed by a certified company.

Seismic kit

Brackets to mount the floor module to the existing floor with anchor bolts

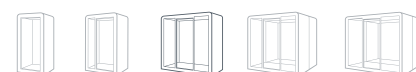

Options for surfaces

Standard colours

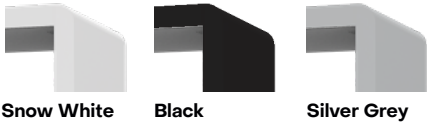

Snow White Black Silver Grey

Veneer



Oak Veneer Dark Oak Veneer

Extra colours

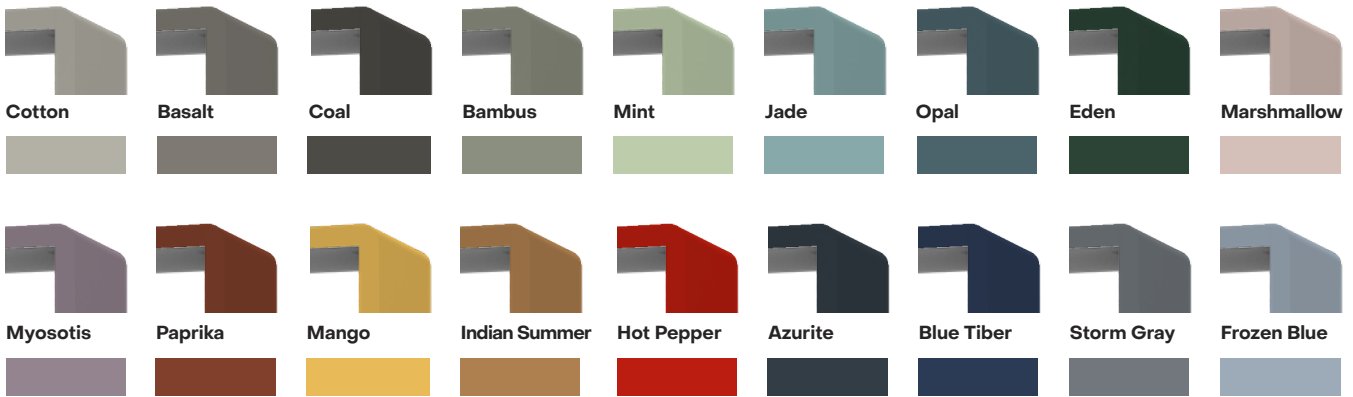

Cotton Basalt Coal Bambus Mint Jade Opal Eden Marshmallow
 Myosotis Paprika Mango Indian Summer Hot Pepper Azurite Blue Tiber Storm Gray Frozen Blue

Standard wall and ceiling

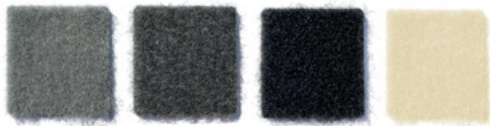

Light gray Dark gray Black Sand

Standard floor

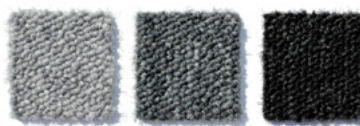

Light gray Dark gray Black

Standard profiles



White Anodized gray Black

Textile sides (Camira Quest)*



Depth Fossil Barnacle Mussel Quartz Shell Ripple Whelk Limpet
 Rock Pool Wave Tide Sea Grass Algae Kelp Sea Foam Urchin Abalone
 Driftwood Sandstone Beach Comber Salt Cockle Crab Clay Shrimp Pebble

* Only for Silen Dynamics Generation

Fully upcycled Furniture textiles with 70% marine plastic content

