

Silen Space 1

Personal escape pod

When you need focus on a call, office noise doesn't help. And your call can distract others nearby. Escape to the pod for silence and privacy.



Ultimate two-way privacy
Market-leading in performance. Blocks 40 dB outside noise, 30 dB (Class A) inside speech. Office-tested, ISO-approved in the laboratory.

Comfortable
Ergonomic, quiet, echo-free, and speech-optimized. Automated LEDs and ventilation. Over twice the standard airflow rate.

Movable
Hidden wheels allow effortless relocation in the office. Prefabricated design offers easy disassembly and reassembly when moving.

Spacious
Ample space to sit, stretch, stand, and move around. Available with furniture of your choice.

Endless customization
Swap side skins and cover trims with a snap of a magnet. Choose from a variety of colors, fabrics, and furnishing options.

Sustainable
Renewable materials used with a 20+ year lifespan. Designed sustainably across materials, production, and impact on surrounding environments.

Interior colour

Standard colours

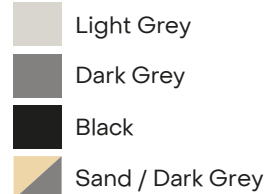

Exterior colour

Standard colours*



Additional colours for extra fee



Fabric colors (Camira RePlay Zero)

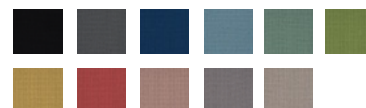

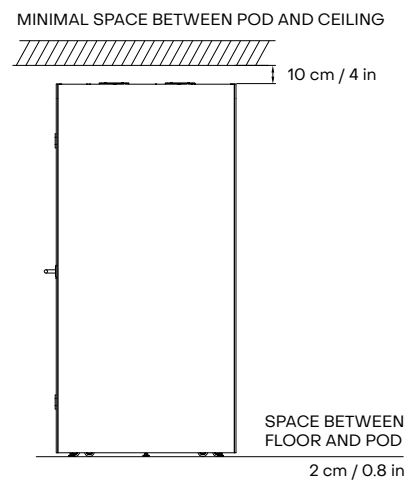
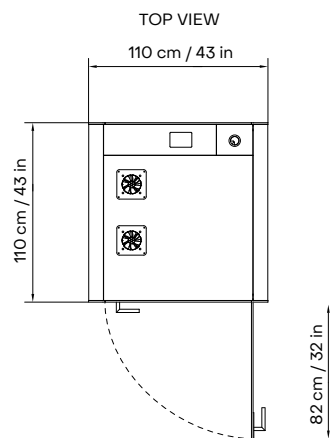
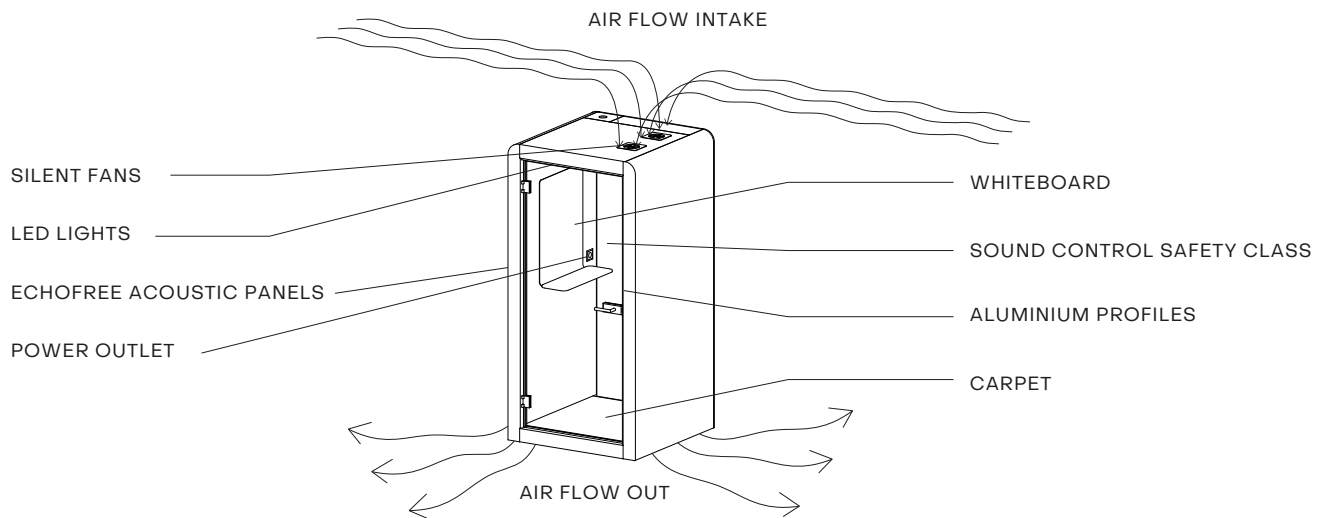
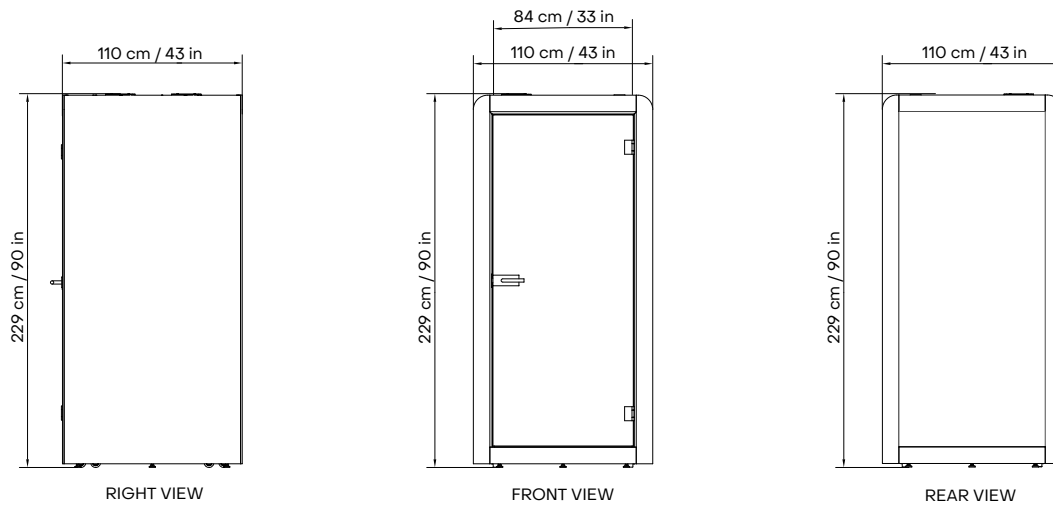

Space 1 technical specification

GENERAL PRODUCT INFO

Exterior size (W×D×H)	110 × 110 × 229 cm / 43 × 43 × 90 in
Interior size (W×D×H)	90 × 101 × 205 cm / 35 × 40 × 81 in
Weight (net)	360 kg / 793.7 lb
Weight with crate	490 kg / 1080.3 lb
Exterior	Side panels: Metal sheet with sand-structured powder coating. Fixed with magnets and easily exchangeable. Front and back trims: Covered with antibacterial laminate. Fixed with magnets and easily exchangeable.
Glass	Sound Control laminated safety glass. Sound insulation STC 40 dB
Walls/structure	EchoFree panel - sandwich element and structure of birch plywood, foam and acoustic felt.
Roof	EchoFree panel - sandwich element of birch plywood and acoustic felt.
Floor	Sandwich element of birch plywood, acoustic wool.
Carpet	Antistatic and stain resistant low loop pile carpet for public spaces, EN 1307. Flammability B _{fl} -s1
Door handedness	Right- or left-handed door. Door handedness must be chosen during order
Furniture	Optional. Different sets are available
Air ventilation	Low energy-consumption automatic air circulation system (stand by 1.7 W; in operation 3.4 W, Max 3.55 W). Air circulation speed is at least 27 l/s
Electrical connections	Black socket with 110-240 V (10 A) + USB-A+C
Power cord	5m long cord with plug type depending on the region. Connection either from the top or bottom of the pod, can be chosen during installation.
Lighting	2700K – 5000K automatic LED lightning (6,7 W, 900 lm) with control panel. Low consumption, energy-efficient
Casters	For moving during installation and easy relocation. Hidden. Can be activated any time.
Adjustable legs	For levelling. Levelling from inside the booth

CERTIFICATION

Product safety	GS-mark / UL962 Listed
Electrical safety	CE-mark / UL962 Listed
Fire safety	Class A according to UL 723, ASTM E84, ASTM E162 (walls and ceiling)
Emissions	Indoor Advantage™ Gold certified by SCS Global Services
Speech level reduction	30,1 dB / Class A according to ISO 23351-1, measured in accredited lab
Airborne sound insulation R'w	40 dB according to ISO 16283-1 and ISO 717-1, measured on site by an accredited specialist
Sound transmission class STC	41 dB according to ASTM E90, measured on site by an accredited specialist



Space 1 extra features



Self-closing door hinges



Retractable coat/bag hook



Control panel



Sprinkler prep



Seismic kit



Occupancy light

EXTRA FEATURE

Self-closing door hinges

LAN/RJ45 connections

Control panel

Airflow dimmer, light brightness dimmer, light temperature selection and controls for optional extras (face light, smart glass etc.)

Face light with or without screen bracket

Two LED light strips in the wall

Occupancy light

Frosted glass

Frosted film between glasses

Integrated stool

Diameter: 35 cm. Height: min 56 cm, max 82 cm

Revolver bar stool

Black, red or gray metal frame, stool turns 360 degrees. Height: 76 cm

Height adjustable table (electrical)

Table top dimensions: 68 x 27 cm. Height: min 70 cm, max 115 cm

Retractable coat/bag hook

Sprinkler prep

Knockout with a tube inside. The ceiling module for housing a sprinkler. Does not include a sprinkler. Sprinkler needs to be installed by a certified company.

Seismic kit

Brackets to mount the floor module to the existing floor with anchor bolts



Options for surfaces

Standard colours



Snow White Black Light Grey

Veneer



Oak Veneer

Extra colours

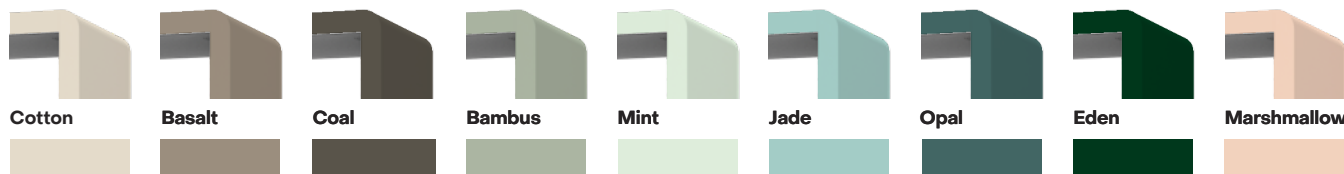

Cotton Basalt Coal Bambus Mint Jade Opal Eden Marshmallow

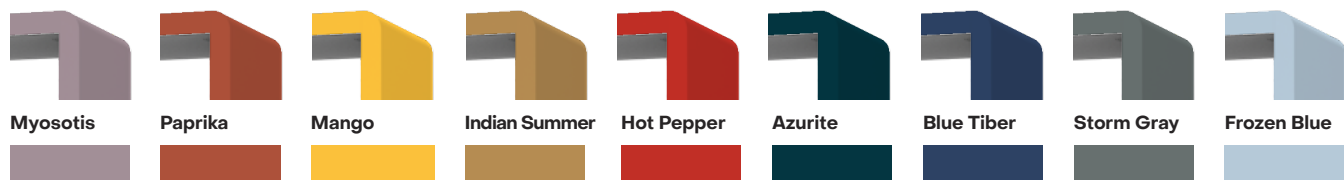

Myosotis Paprika Mango Indian Summer Hot Pepper Azurite Blue Tiber Storm Gray Frozen Blue

Standard wall and ceiling



Light gray Dark gray Black Sand

Standard floor

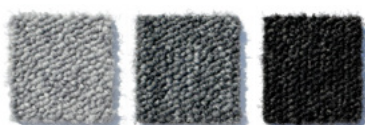

Light gray Dark gray Black

Standard profiles



White Anodized gray Black

Fabric colors (Camira RePlay Zero)*

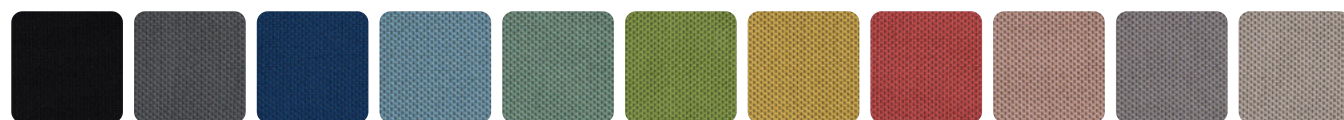

Black (ZER33) Dark Grey (ZER29) Navy Blue (ZER02) Slate Blue (ZER01) Eucalyptus Green (ZER07) Moss Green (ZER12) Honey Yellow (ZER17) Dusty Red (ZER20) Powder Pink (ZER15) Light Grey (ZER26) Cool Beige (ZER25)

* Only for Silen Dynamics Generation



Space 1 furnishing options

Gagarin

A nod to solo space flight, this module is designed for pure, individual focus. It's a minimalist pod with a table and an integrated stool. Nothing distracts from your self-guided mission.

INCLUDES:

- Fully integrated and adjustable stool
- Antibacterial table top

INTEGRATED STOOL

Diameter: 35 cm

Height: min 56 cm, max 82 cm

Adjustable leg: black (with chrome bottom tube)

Seat fabric: dark gray (RePlay Zero ZER29).

TABLE TOP

White with antibacterial laminate 68 x 27 cm, height 105 cm

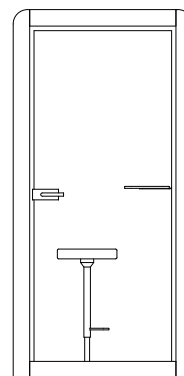
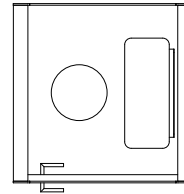

Houston

If you wish to connect your own devices and install your own screen to Silen Space 1, the Houston module is your perfect companion.

INCLUDES:

- Universal bracket for 24-in screen, recessed into the wall (screen not included)
- Control panel for dimming and controlling features
- Extra face lights and video-call light mode
- Tray and feedthrough for connection cables
- Antibacterial table top
- Revolver stool

REVOLVER BAR STOOL

Black, red or gray metal frame, stool turns 360 degrees

Height: 76 cm

Weight: 10 kg

TABLE TOP

White with antibacterial laminate 68 x 27 cm, height 105 cm

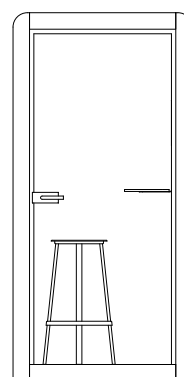
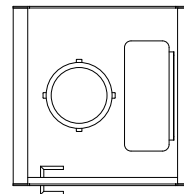

Space 1 furnishing options

Apollo

Some work just takes longer. When that happens, the Apollo module will serve you well. Whether you work while sitting or standing, use electrical adjustment to find the most comfortable table height. Pro tip: use it to raise your laptop camera to eye level for video calls.

INCLUDES:

- Electrically height adjustable table with antibacterial worktop
- Revolver stool

REVOLVER BAR STOOL

Black, red or gray metal frame, stool turns 360 degrees

Height: 76 cm

Weight: 10 kg

HEIGHT ADJUSTABLE TABLE (electrical)

Table top dimensions: 68 x 27 cm

Height: min 70 cm, max 115 cm

Table top: white (antibacterial) laminated MDF, lifting mechanism located inside the wall module

