



Silen Space 2 Hybrid

A welcoming space for everyone

Sharp minds move in various ways. This pod is designed to accommodate everyone.

 1-4 people



 **Accessible**
Improved comfort and wheelchair access with an extra-low threshold and a wide door, with an optional automatic opening.

 **Ultimate two-way privacy**
Market-leading sound reduction for wheelchair-accessible office pods.

 **Comfortable**
Ergonomic, quiet, echo-free, and speech-optimized. Automated LEDs and ventilation. Over twice the standard airflow rate.

 **Easy to relocate**
Add-on mobility kit for in-office relocation. Easy reassembly for moving offices.

 **Spacious**
Suitable for 2 wheelchair users; otherwise, seats up to 4. Offers ample space to stretch and move around. Available with furniture of your choice.

 **Endless customization**
Swap side skins and cover trims with a snap of a magnet. Enjoy a variety of colors, fabrics, and furnishing options.

 **Modularity**
The modular design enables changing the pod size whenever needed. Add modules to create bigger spaces or split larger pods into smaller spaces.

 **Sustainable**
Renewable materials used with a 20+ year lifespan. Designed sustainably across materials, production, and impact on surrounding environments.

 **Interior colour**

Standard colours



 **Exterior colour**

Standard colours*

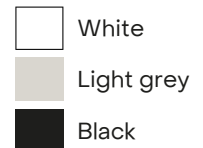

Additional colours for extra fee



Fabric colors (Camira RePlay Zero)

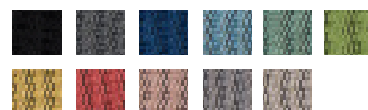

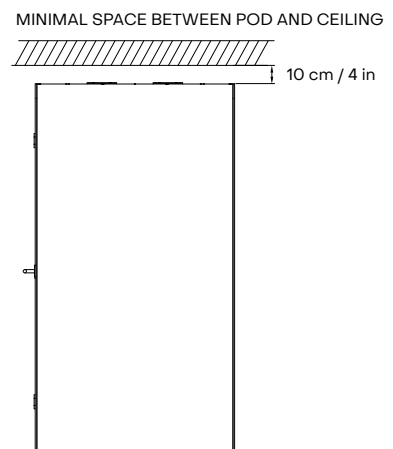
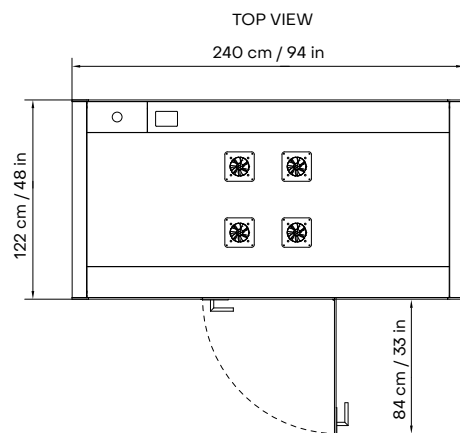
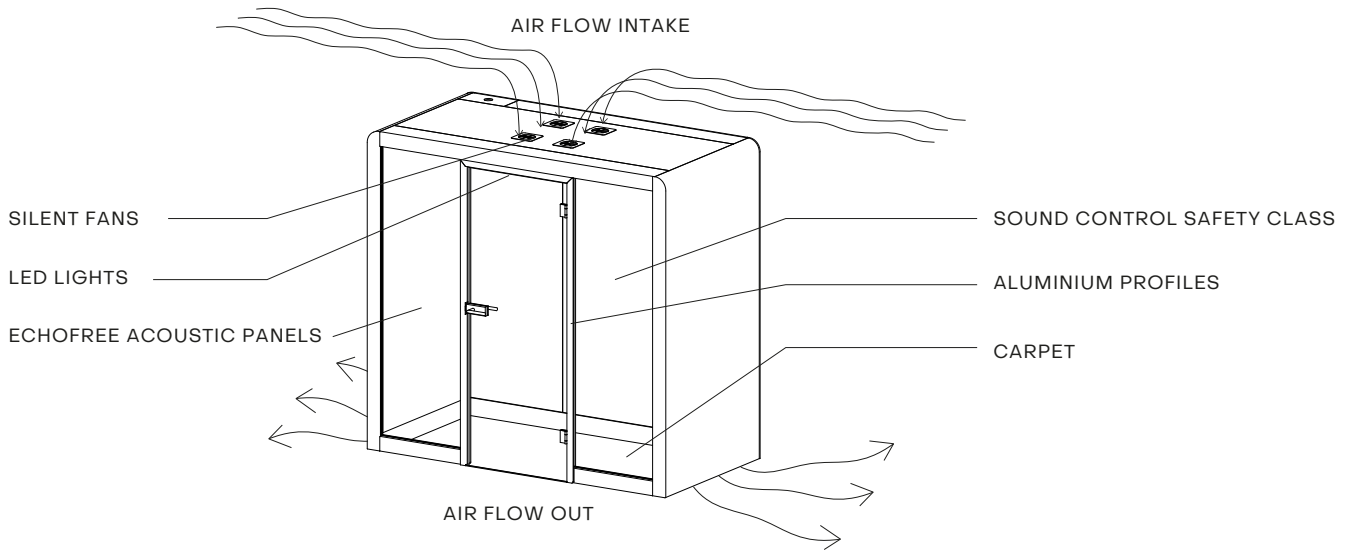
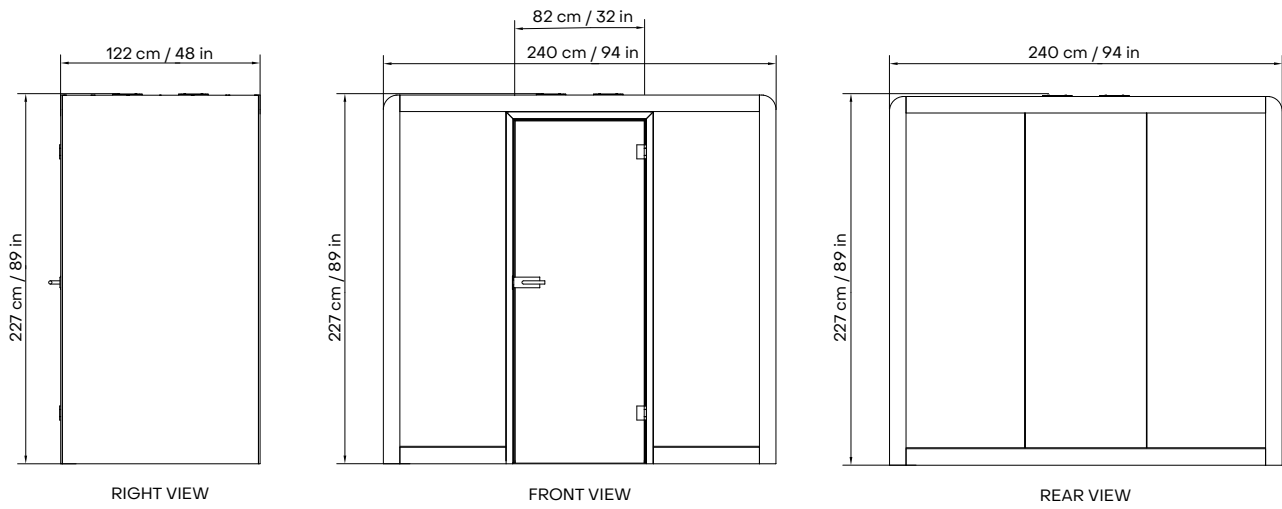

Space 2 Hybrid technical specification

GENERAL PRODUCT INFO

Exterior size (W×D×H)	240 × 122 × 227 cm / 94 × 48 × 89 in
Interior size (W×D×H)	220 × 110 × 216 cm / 87 × 43 × 85 in
Weight (net)	650 kg / 1433 lb
Weight with crate	780 kg / 1719 lb
Exterior	<p>Side panels: Metal sheet with sand-structured powder coating. Fixed with magnets and easily exchangeable.</p> <p>Front and back trims: Covered with antibacterial laminate (MDF). Fixed with magnets and easily exchangeable.</p>
Glass	Sound Control laminated safety glass. Sound insulation STC 40 dB
Walls/structure	EchoFree panel - sandwich element and structure of birch plywood, foam and acoustic felt.
Roof	EchoFree panel - sandwich element of birch plywood and acoustic felt.
Floor	Frame of birch plywood, acoustic wool.
Carpet	Antistatic and stain resistant low loop pile carpet for public spaces, EN 1307. Flammability B _{fl} -s1
Door handedness	Right- or left-handed door. Door handedness can be chosen during order
Furniture	Optional. Different sets are available
Air ventilation	Low energy-consumption automatic air circulation system (stand by 3,4W; in operation 6,8W). Air circulation speed is at least 85 l/s
Electrical connections	Option one: add foldable table for sockets Option two: 2 x 110-240 V + USB-A+C from floor frame
Power cord	5m long cord with plug type depending on the region. Connection either from the top or bottom of the pod, can be chosen during installation.
Lighting	2700K – 5000K automatic LED lightning (28 W, 3000 lm) with control panel. Low consumption, energy-efficient

CERTIFICATION

Product safety	UL962 Listed
Electrical safety	CE-mark / UL962 Listed
Fire safety	Class A according to UL 723, ASTM E84, ASTM E162 (walls and ceiling)
Emissions	Indoor Advantage™ Gold certified by SCS Global Services



Space 2 Hybrid extra features



Retractable coat/bag hook



Control panel



Occupancy light

EXTRA FEATURE

Control panel	Airflow dimmer, light brightness dimmer, light temperature selection and controls for optional extras (face light, smart glass etc.)
Occupancy light	
Frosted film between glass	
Retractable coat/bag hook	
Sprinkler prep	Knockout with a tube inside. The ceiling module for housing a sprinkler. Does not include a sprinkler. Sprinkler needs to be installed by a certified company.
Seismic kit	Brackets to mount the floor module to the existing floor with anchor bolts
Mobility kit	Set of detachable casters for moving booths. Can be used for all Space Hybrid models.
Foldable jumpseat	Width 50 cm
Foldable table with gas-spring & power socket	Dimensions: 58 x 74 cm, height 74 cm
Vega sofa low-back	Dimensions: 113 x 62 x H78 cm, seat height 46 cm. Sofa fabric colour: Standard colours: Light gray, dark gray, black
Vega sofa high-back	Dimensions: 113 x 62 x H128 cm, seat height 46 cm. Sofa fabric colour: Standard colours: Light gray, dark gray, black



Options for surfaces

Standard colours



Snow White Black Light Grey

Veneer



Oak Veneer

Extra colours



Cotton Basalt Coal Bambus Mint Jade Opal Eden Marshmallow
 Myosotis Paprika Mango Indian Summer Hot Pepper Azurite Blue Tiber Storm Gray Frozen Blue

Standard wall and ceiling

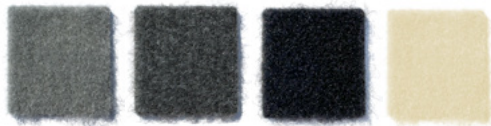

Light gray Dark gray Black Sand

Standard floor

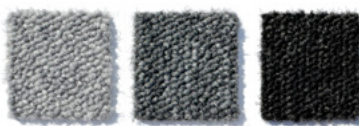

Light gray Dark gray Black

Standard profiles



White Anodized gray Black

Fabric colors (Camira RePlay Zero)*



Black (ZER33) Dark Grey (ZER29) Navy Blue (ZER02) Slate Blue (ZER01) Eucalyptus Green (ZER07) Moss Green (ZER12) Honey Yellow (ZER17) Dusty Red (ZER20) Powder Pink (ZER15) Light Grey (ZER26) Cool Beige (ZER25)

* Only for Silen Dynamics Generation

